

APPLICAZIONI

Elettropompe centrifughe bigiranti per sollevare acqua pulita e liquidi moderatamente carichi di impurità non aggressivi per i materiali delle pompe. Caratteristica principale è l'impiego di due giranti contrapposte che permettono, a differenza del modello monogirante, elevate prevalenze. Adatte per impianti civili e industriali, distribuzione automatica dell'acqua a mezzo di piccoli-medi serbatoi (autoclave) e per irrigazione a pioggia in giardino e in agricoltura.

APPLICATION

Twin impeller centrifugal water pumps to lift clean water and non-aggressive liquids. The main feature are the two opposite impellers which allow higher lifts than in the single-impeller model. They are qualified for civil and industrial fittings, for water distribution by tank pressure groups and for irrigation in gardening and agriculture.

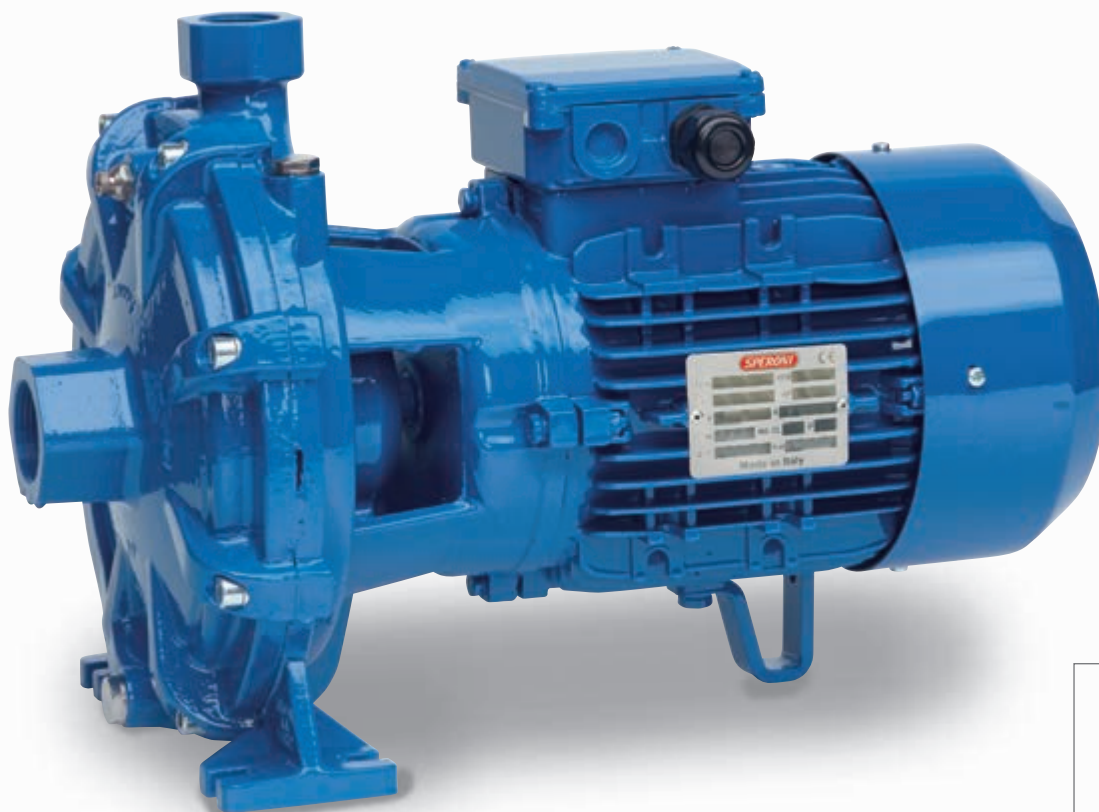

GIRANTE - IMPELLER

LIMITI D'IMPIEGO

- Temperatura liquido fino a 35°C (per un uso domestico secondo EN 60335-2-41)
- Temperatura max. liquido: 90°C (per altri impieghi)
- Temperatura ambiente fino a 40°C
- Altezza d'aspirazione manometrica fino a 7 mt.
- Servizio continuo

MOTORE

- Monofase 230V-50Hz
- Trifase 230/400V-50Hz $P_2 \leq 7,5$ kW
- Trifase 400/690V-50Hz $P_2 > 7,5$ kW
- Motore elettrico ad induzione a 2 poli ($n = 2850$ min⁻¹)
- Isolamento Classe F
- Protezione IP 55

MATERIALI

- | | |
|---------------------|-----------------------|
| - Corpo pompa | Ghisa |
| - Supporto motore | Ghisa |
| - Giranti | Ottone |
| - Albero motore | Acciaio Inox AISI 304 |
| - Tenute meccaniche | Ceramica/Grafite/NBR |

OPERATING CONDITIONS

- Liquid temperature up to 35°C (for home use according to EN 60335-2-41)
- Temperature max. liquid: 90°C (for other uses)
- Ambient temperature up to 40°C
- Total suction lift up to 7 mt.
- Continuous duty

MOTOR

- Single-phase 230V-50Hz
- Three-phase 230/400V-50Hz $P_2 \leq 7,5$ kW
- Three-phase 400/690V-50Hz $P_2 > 7,5$ kW
- Two-Pole induction motor ($n = 2850$ min⁻¹)
- Insulation Class F
- Protection IP 55

MATERIALS

- | | |
|--------------------|--------------------------|
| - Pump body | Cast Iron |
| - Motor Support | Cast Iron |
| - Impellers | Brass |
| - Shaft with rotor | Stainless Steel AISI 304 |
| - Mechanical seal | Ceramic/Graphite/NBR |

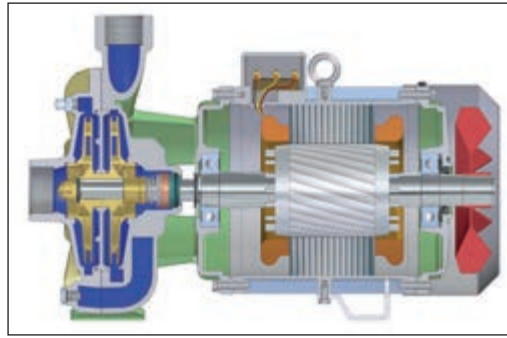

TIPO TYPE		POTENZA NOMINALE NOMINAL POWER		POTENZA ASSORBITA INPUT POWER	AMPERE		Q = PORTATA - CAPACITY											
Monofase Single-phase	Trifase Three-phase	P2		P1	Monofase Single-phase	Trifase Three-phase	m ³ /h	1,2	2,4	3,6	4,8	6	7,2	8,4	9,6	10,8	12	
		HP	kW				kW	lt/1'	20	40	60	80	100	120	140	160	180	200
							Prevalenza manometrica totale in m.C.A. - Total head in meters w.c.											
2CM 25/160C	2C 25/160C	1,5	1,1	2,2	10	4,3	H (m)	51	49	47	44	40	35	27	23			
2CM 25/160BC		2	1,5	2,4	11			54	52	49	46	42	36	28	26			
	2C 25/160B	2	1,5	2,6		5		58	56	53,5	50	47,5	42	35	31			
2CM 25/160BA	2C 25/160BA	2,5	1,85	2,8	13	5,2		61	59	57	54	48	42	35	33			
2CM 25/160A	2C 25/160A	3	2,2	3,6	16	5,7		65	62,5	61	59	57	54	50,5	46			
	2C 25/180A	4	3	4,2		7		70	68	65	63	60	57	54	49	44	39	

TIPO TYPE		POTENZA NOMINALE NOMINAL POWER		POTENZA ASSORBITA INPUT POWER	AMPERE		Q = PORTATA - CAPACITY											
Monofase Single-phase	Trifase Three-phase	P2		P1	Monofase Single-phase	Trifase Three-phase	m ³ /h	1,2	2,4	3,6	4,8	6	7,2	8,4	9,6	10,8	12	
		HP	kW				kW	lt/1'	20	40	60	80	100	120	140	160	180	200
							Prevalenza manometrica totale in m.C.A. - Total head in meters w.c.											
2CM 32/190C	2C 32/190C	3	2,2	3,6	16	5,7	H (m)	63	60	58	56	54	50	46				
	2C 32/190B	4	3	4,5		7,5		74	72	69,5	65	63	60	56	54	49	43	
2CM 32/190A	2C 32/190A	5,5	4	6	29	9,3		88	86	84	80	77	74	68	64	60	56	

TIPO TYPE		POTENZA NOMINALE NOMINAL POWER		POTENZA ASSORBITA INPUT POWER	AMPERE		Q = PORTATA - CAPACITY											
Monofase Single-phase	Trifase Three-phase	P2		P1	Monofase Single-phase	Trifase Three-phase	m ³ /h	0	1,5	3	4,5	6	9	12	15	18	21	
		HP	kW				kW	lt/1'	0	25	50	75	100	150	200	250	300	350
							Prevalenza manometrica totale in m.C.A. - Total head in meters w.c.											
2CM 32/210D	2C 32/210D	5,5	4	6	29	9,3	H (m)	79	78,8	78,5	77,3	75,5	70	62	50			
	2C 32/210C	7,5	5,5	8		13		90	89,5	89	88	87	82,5	76	60	49		
	2C 32/210B	10	7,5	10		16		105,5	105,3	105	104	102,5	98	91	82	68		
	2C 32/210A	12,5	9,2	11,5		18,5		117	116,8	116,5	115,5	114,5	110	103	94	82		
	2C 32/215A	15	11	13		21		120	119,8	119,5	118,5	117,5	112	105	96	84	67	

TIPO TYPE		POTENZA NOMINALE NOMINAL POWER		POTENZA ASSORBITA INPUT POWER	AMPERE		Q = PORTATA - CAPACITY											
Monofase Single-phase	Trifase Three-phase	P2		P1	Monofase Single-phase	Trifase Three-phase	m ³ /h	0	3	6	9	15	18	24	27	30	36	
		HP	kW				kW	lt/1'	0	50	100	150	250	300	400	450	500	600
							Prevalenza manometrica totale in m.C.A. - Total head in meters w.c.											
2CM 40/180D	2C 40/180D	5,5	4	6	29	9,3	H (m)	60	59	58	56	50	45	34	25			
	2C 40/180C	7,5	5,5	8		13		71	70,7	70,5	69	64	60	50	43	35		
	2C 40/180B	10	7,5	10		16		87	86	85	83	78	75	65	60	51		
	2C 40/180A	12,5	9,2	11,5		18,5		93,5	93,3	93	92	87	82	71	65	58		
	2C 40/200A	15	11	13		21		96	95,8	95,5	94,5	90	86	77	71	65	48	

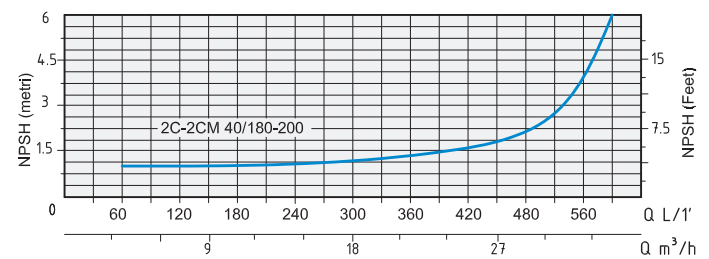
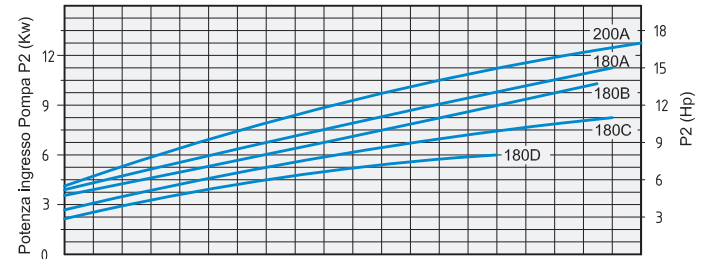
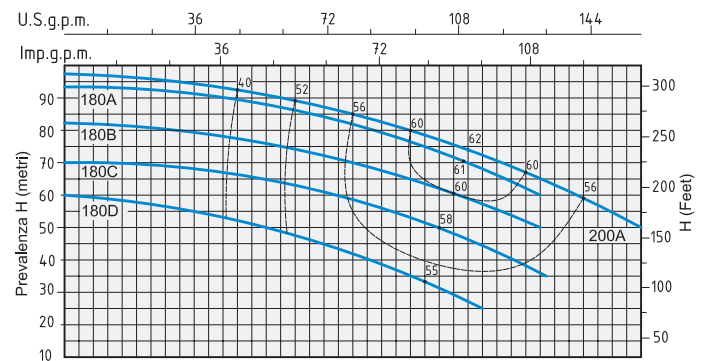
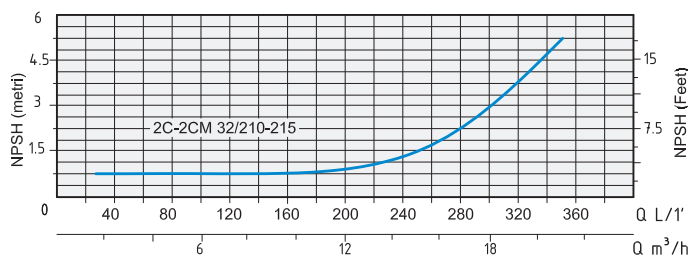
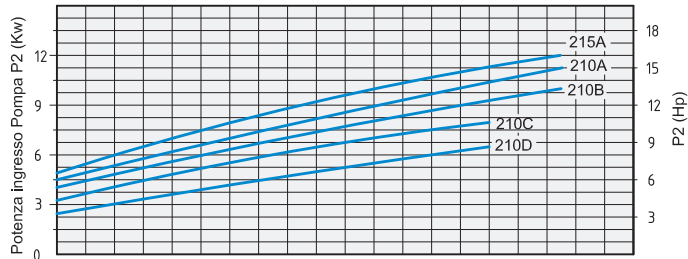
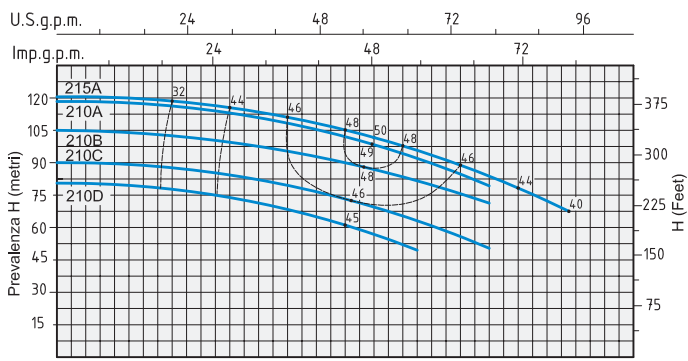
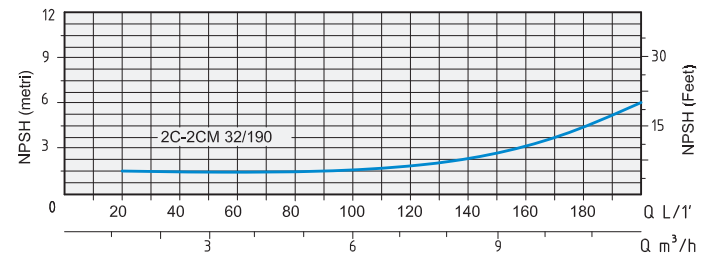
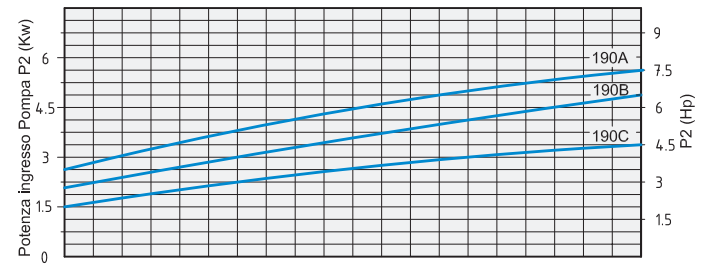
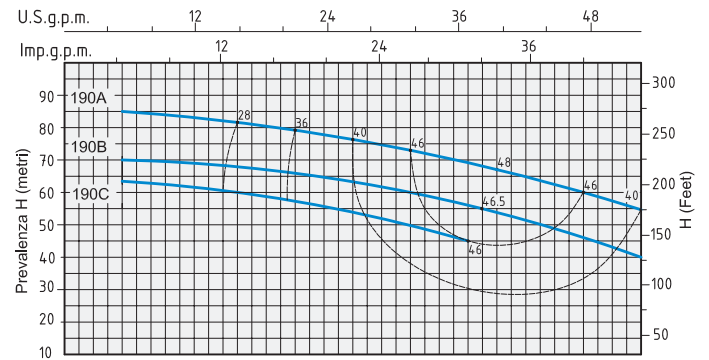
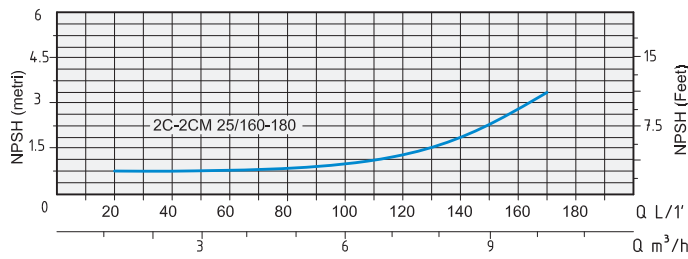
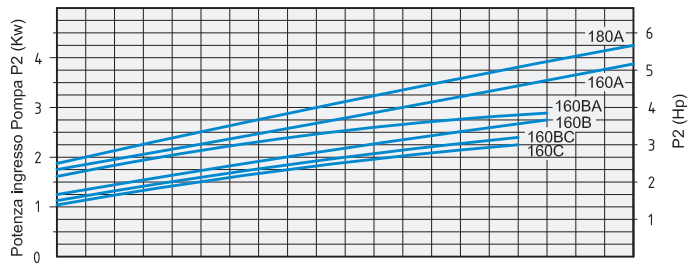
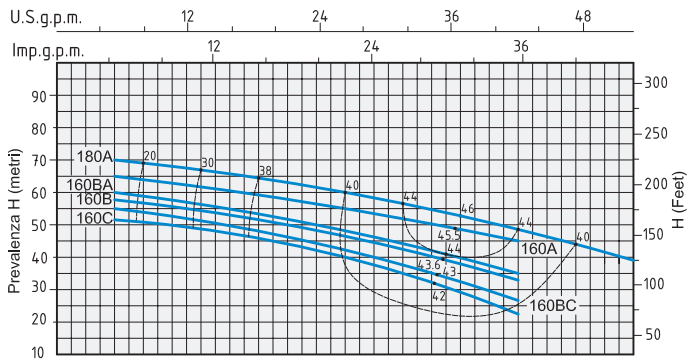

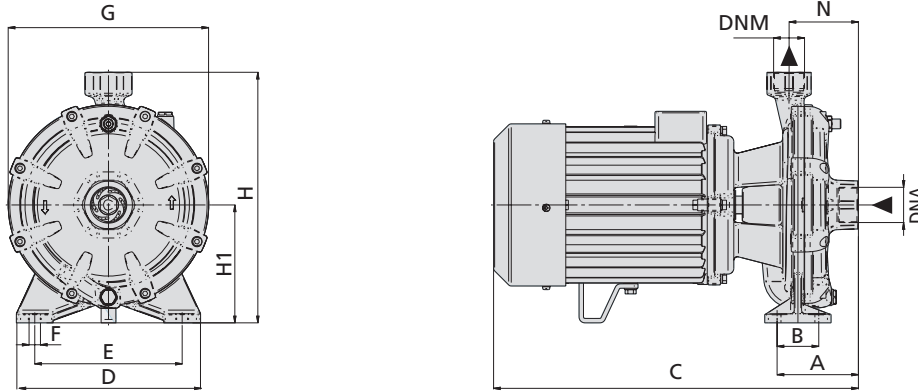

TIPO TYPE		DIMENSIONI mm - DIMENSIONS mm												DIMENSIONI DIMENSIONS mm			PESO WEIGHT
Monofase Single-phase	Trifase Three-phase	A	B	C	D	E	F	G	H	H1	N	DNA	DNM	P	L	H	Kg
2CM 25/160C	2C 25/160C	95	50	400	208	168	10	222	265	120	85	1" 1/4	1"	240	414	314	24,6
		95	50	432	208	168	10	222	265	120	85	1" 1/4	1"	240	414	314	26,4
	2C 25/160B	95	50	432	208	168	10	222	265	120	85	1" 1/4	1"	240	414	314	24,6
2CM 25/160BA	2C 25/160BA	95	46	432	208	168	10	222	265	120	85	1" 1/4	1"	259	507	345	29,9
2CM 25/160A	2C 25/160A	108,5	46	440	230	190	12	246	290	132	92,5	1" 1/4	1"	259	507	345	36,1
	2C 25/180A	108,5	46	440	230	190	12	246	290	132	92,5	1" 1/4	1"	310	530	460	35,9

TIPO TYPE		DIMENSIONI mm - DIMENSIONS mm												DIMENSIONI DIMENSIONS mm			PESO WEIGHT
Monofase Single-phase	Trifase Three-phase	A	B	C	D	E	F	G	H	H1	N	DNA	DNM	P	L	H	Kg
2CM 32/190C	2C 32/190C	120	60	450	250	200	15	272	340	160	94	1" 1/2	1" 1/4	310	530	460	40,7
	2C 32/190B	120	60	485	250	200	15	272	340	160	94	1" 1/2	1" 1/4	310	530	460	44,9
2CM 32/190A	2C 32/190A	120	60	495	250	200	15	272	340	160	94	1" 1/2	1" 1/4	310	530	460	53,9

TIPO TYPE		DIMENSIONI mm - DIMENSIONS mm												DIMENSIONI DIMENSIONS mm			PESO WEIGHT
Monofase Single-phase	Trifase Three-phase	A	B	C	D	E	F	G	H	H1	N	DNA	DNM	P	L	H	Kg
2CM 32/210D	2C 32/210D	121	60	530	280	225	15	300	375	160	107	2"	1" 1/4	342	620	475	60
	2C 32/210C	121	60	575	280	225	15	300	375	160	107	2"	1" 1/4	342	620	475	70,6
	2C 32/210B	121	60	575	280	225	15	300	375	160	107	2"	1" 1/4	342	620	475	75,4
	2C 32/210A	121	60	575	280	225	15	300	375	160	107	2"	1" 1/4	372	805	550	91,1
	2C 32/215A	121	60	612	280	225	15	300	375	160	107	2"	1" 1/4	372	805	550	96,1

TIPO TYPE		DIMENSIONI mm - DIMENSIONS mm												DIMENSIONI DIMENSIONS mm			PESO WEIGHT
Monofase Single-phase	Trifase Three-phase	A	B	C	D	E	F	G	H	H1	N	DNA	DNM	P	L	H	Kg
2CM 40/180D	2C 40/180D	126	60	535	280	225	15	300	375	160	116	2"	1" 1/2	342	620	475	60,9
	2C 40/180C	126	60	580	280	225	15	300	375	160	116	2"	1" 1/2	342	620	475	71,2
	2C 40/180B	126	60	580	280	225	15	300	375	160	116	2"	1" 1/2	342	620	475	72,6
	2C 40/180A	126	60	580	280	225	15	300	375	160	116	2"	1" 1/2	372	805	550	94,1
	2C 40/200A	126	60	612	280	225	15	300	375	160	116	2"	1" 1/2	372	805	550	97,1